

X2-10CWxx-80C

CWDM X2-10GBASE, 80km Reach

Features

- Wavelength selectable to ITU-T standards covering CWDM grid
- Compatible with X2 MSA Rev2.0b
- Support of IEEE 802.3ae 10GBASE-ER at 10.3125Gbps
- Transmission Distance up to 80Km(SMF)
- SC Receptacle CWDM Cooled EA Laser and APD photodiode
- SC Duplex Optical Connector
- Hot Pluggable 70-PIN Connector with XAUI Electrical Interface
- Management and control via MDIO 2-wire interface
- Power Supply : +5V, +3.3V, APS(+1.2V)
- Diagnostic Optics Monitoring
- Temperature Range: -5~ 70 °C
- ROHS Compatible



Applications

- 10GE Ethernet switches and routers
- 10GE Core-routers
- 10GE Storage
- CWDM System

Product Description

The X2-10CWxx-80C is a highly integrated, Serial optical transponder module for high-speed, 10Gbit/s data transmission applications. 4×3.125Gbps Ethernet Signal Input by XAUI Interface. An integrated Coder / Decoder and multiplexer / demultiplexer (SERDES: Serializer / Deserializer). Designing for 80km Transmission with an uncooled directly modulated CWDM Cooled EA-DFB Laser. Digital diagnostics functions are available via a 2-wire serial interface, as specified in the XENPAK MSA 3.0.

Absolute Maximum Ratings

| Parameter | Symbol | Min | Max | Unit | Ref. |
|-----------------------------------|----------|------|-----|------|-------------------------|
| Storage Ambient Temperature Range | | -40 | +85 | °C | non condensing |
| Powered case Temperature Range | | 0 | +70 | °C | non condensing |
| Adaptable Power Supply (APS) | Vapsense | 0 | 1.5 | V | Voltage @ Pin APS Sense |
| Supply Voltage Range @ 3.3V | Vcc3 | -0.5 | 4.0 | V | |

Any stress beyond the maximum ratings can result in permanent damage. The device specifications are guaranteed only under the recommended operating conditions.

Recommended Operating Conditions

| Parameter | Symbol | Min | Typical | Max | Unit |
|----------------------------|------------------|-------|---------|-------|------|
| Operating Case Temperature | Tc | 0 | | +70 | °C |
| Power Supply Voltage | V _{CC5} | 4.75 | 5.0 | 5.25 | V |
| | V _{CC3} | 3.14 | 3.3 | 3.47 | |
| | V _{APS} | 1.152 | 1.2 | 1.248 | |
| Power Dissipation | PD | | | 4 | W |

XAUI I/O Characteristics

| Parameter | Symbol | Min. | Typ. | Max. | Unit | Note |
|-----------------------------------|--------|------|-------|------|-------|---------------------------|
| XAUI Data Rate | DR | | 3.125 | | Gb/s | |
| XAUI Baud Rate Tolerance | | -100 | | +100 | ppm | Relative Tolerance |
| Differential Input Voltage Swing | | 220 | | 1600 | mv | 8B/10B Coded Input Signal |
| Differential Output Voltage Swing | | 800 | | 1600 | mVp-p | RLOAD = 100Ω ± 5% |
| Differential Input Impedance | | 80 | 100 | 120 | Ω | |
| Total Output Jitter | TJXAUI | | | 0.35 | UI | no pre-equalization |
| Total Deterministic Output Jitter | DJXAUI | | | 0.17 | UI | no pre-equalization |

Optical Interface

Transmitter Characteristics

| Parameter | Symbol | Min. | Typ. | Max. | Unit | Note |
|------------------------------------|-------------------|------|-------------|------|---------|------|
| Operating Range | | | | 10 | Km | |
| Operating Data Rate | | | 10.3125 | | Gb/s | |
| Optical Transmit Power | Po | -1.0 | | +2.0 | dBm | |
| Output Centre Wavelength | λ_c | 1470 | | 1610 | nm | |
| Center wavelength stability | $\Delta\lambda_c$ | -6.5 | λ_c | +6.5 | nm | |
| SMSR. | SWSR | 30 | | | dB | |
| Extinction Ratio | ER | 9.0 | | | | |
| Optical Modulation Amplitude | OMA | 500 | | | μ W | |
| Transmitter and Dispersion Penalty | TDP | | | 3.2 | dB | |

Receiver Characteristics







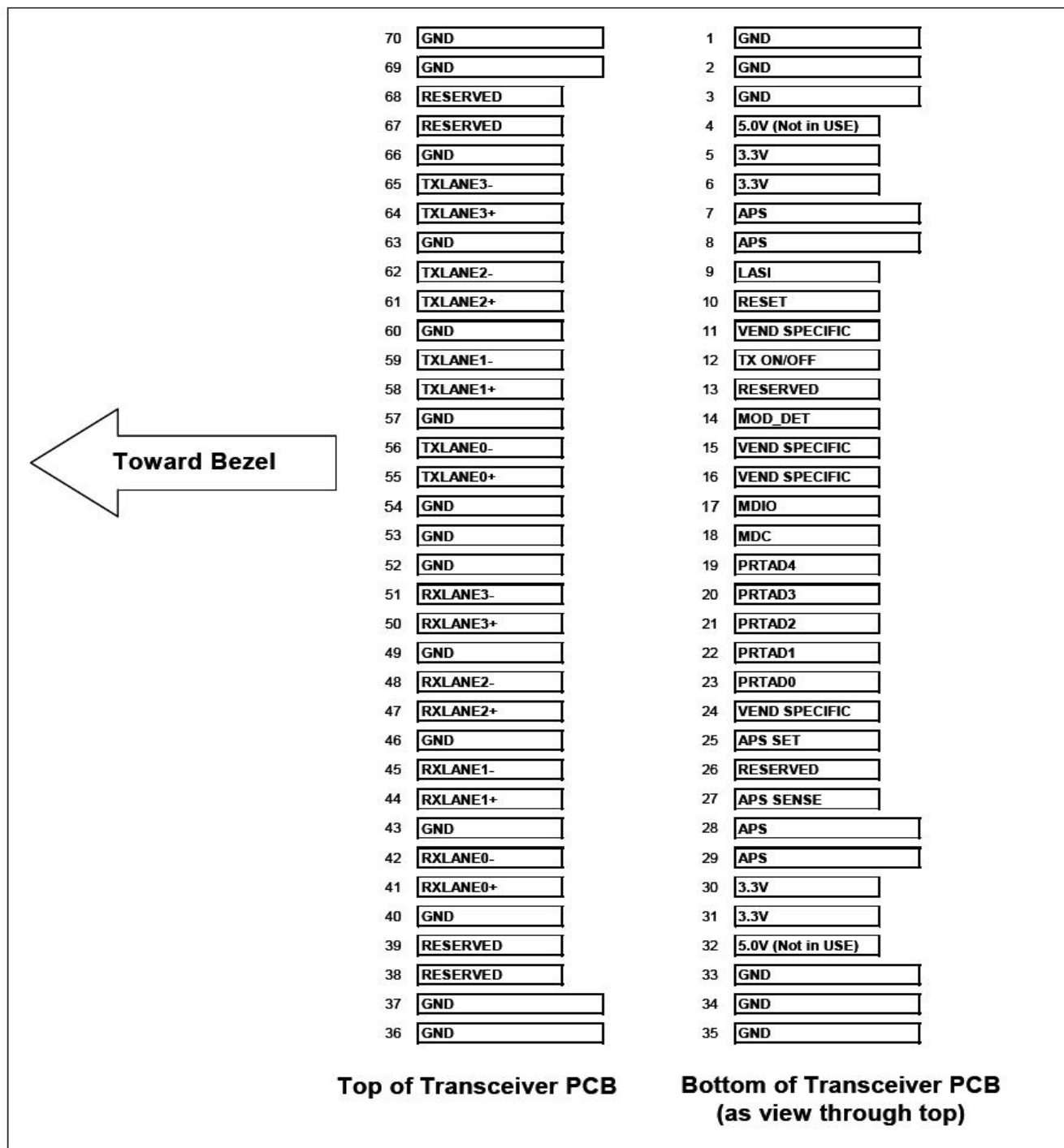































































| Parameter | Symbol | Min. | Typ. | Max. | Unit | Note |
|------------------------------------|--------|------|---------|-------|------|------|
| Operating Data Rate | | | 10.3125 | | Gb/s | |
| Overload | Po | 0.5 | | | dBm | |
| Sensitivity in 10.3G(OMA) | OMA0 | | | -23.5 | dBm | 1 |
| Stressed Sensitivity in 10.3G(OMA) | OMAst | | | -22.0 | dBm | 1 |
| | | | | | | |

Note :1. Measured at 10.3125Gb/s, Non-framed PRBS2³¹-1,NRZ

Electrical PAD Layout



Host PCB X2 PINOUT

| | | | |
|----|---|--|----|
| 1 |  GND | GND  | 70 |
| 2 |  GND | GND  | 69 |
| 3 |  GND | RESERVED  | 68 |
| 4 |  5.0V (Not in USE) | RESERVED  | 67 |
| 5 |  3.3V | GND  | 66 |
| 6 |  3.3V | TXLANE3-  | 65 |
| 7 |  APS | TXLANE3+  | 64 |
| 8 |  APS | GND  | 63 |
| 9 |  LASI | TXLANE2-  | 62 |
| 10 |  RESET | TXLANE2+  | 61 |
| 11 |  VEND SPECIFIC | GND  | 60 |
| 12 |  TX ON/OFF | TXLANE1-  | 59 |
| 13 |  RESERVED | TXLANE1+  | 58 |
| 14 |  MOD_DET | GND  | 57 |
| 15 |  VEND SPECIFIC | TXLANE0-  | 56 |
| 16 |  VEND SPECIFIC | TXLANE0+  | 55 |
| 17 |  MDIO | GND  | 54 |
| 18 |  MDC | GND  | 53 |
| 19 |  PRTAD4 | GND  | 52 |
| 20 |  PRTAD3 | RXLANE3-  | 51 |
| 21 |  PRTAD2 | RXLANE3+  | 50 |
| 22 |  PRTAD1 | GND  | 49 |
| 23 |  PRTAD0 | RXLANE2-  | 48 |
| 24 |  VEND SPECIFIC | RXLANE2+  | 47 |
| 25 |  APS SET | GND  | 46 |
| 26 |  RESERVED | RXLANE1-  | 45 |
| 27 |  APS SENSE | RXLANE1+  | 44 |
| 28 |  APS | GND  | 43 |
| 29 |  APS | RXLANE0-  | 42 |
| 30 |  3.3V | RXLANE0+  | 41 |
| 31 |  3.3V | GND  | 40 |
| 32 |  5.0V (Not in USE) | RESERVED  | 39 |
| 33 |  GND | RESERVED  | 38 |
| 34 |  GND | GND  | 37 |
| 35 |  GND | GND  | 36 |

Pin Descriptions

| PIN NO | Name | Dir | Logic | Function | Notes |
|--------|------------------|-----|-------------------------|---|-------|
| 1 | GND | | | Electrical Ground | |
| 2 | GND | | | Electrical Ground | |
| 3 | GND | | | Electrical Ground | |
| 4 | 5.0V | | | Power | |
| 5 | 3.3V | | | Power | |
| 6 | 3.3V | | | Power | |
| 7 | APS | | | Adaptive Power Supply | |
| 8 | APS | | | Adaptive Power Supply | |
| 9 | LASI | O | 1.2V CMOS Open Drain | Link Alarm Status Interrupt, low active, Open Drain Output A pull-up resistor with 10-22KΩ to 1,2V is expected. Logic High: Normal Operation Logic Low: Link Alarm is indicated | |
| 10 | Reset | I | 1.2V CMOS Open Drain | Low active Reset Input 10KΩ pull-up on Transceiver Logic high = Normal Operation Logic Low = Reset asserted | |
| 11 | VEND SPECIFIC | | | Vendor Specific Pin,, leave unconnected | |
| 12 | TX ON/OFF | I | 1.2V CMOS Open Drain | High active Transmitter Enable Input 10KΩ pull-up on Transceiver Logic high = Transmitter active (normal Operation) And Register Bit 1.9.0 set to low as well Logic Low = shut down of Transmitter | |
| 13 | RESERVED | | | RESERVED | |
| 14 | MOD DETECT | O | | 1kΩ to Ground On Transceiver | |
| 15 | VEND SPECIFIC | | | Vendor Specific Pin,, leave unconnected | |
| 16 | VEND SPECIFIC | | | Vendor Specific Pin,, leave unconnected | |
| 17 | MDIO | I/O | 1.2V CMOS | Management Data I/O. Requires external 10-22 kΩ pull- up to 1.2 V on host. | |
| 18 | MDC | I | 1.2V CMOS | Management Clock Input | |
| 19 | PRTAD4 | I | | Port Address Bit 4(LOW=0) | |
| 20 | PRTAD3 | I | | Port Address Bit 3(LOW=0) | |
| 21 | PRTAD2 | I | | Port Address Bit 2(LOW=0) | |
| 22 | PRTAD1 | I | | Port Address Bit 1(LOW=0) | |
| 23 | PRTAD0 | I | | Port Address Bit 0(LOW=0) | |
| 24 | VEND SPECIFIC | | | Vendor Specific Pin,, leave unconnected | |
| 25 | APS SET | I | | Feedback Input for APS, Input of APS Setting Resistor | |
| 26 | RESERVED | | | RESERVED | |

| | | | | | |
|----|------------|---|--|--|--|
| 27 | APS SENSE | O | | APS Sense Output for APS Control Circuit | |
| 28 | APS | | | Adaptive Power Supply | |
| 29 | APS | | | Adaptive Power Supply | |
| 30 | 3.3V | | | Power | |
| 31 | 3.3V | | | Power | |
| 32 | 5.0V | | | Power | |
| 33 | GND | | | Electrical Ground | |
| 34 | GND | | | Electrical Ground | |
| 35 | GND | | | Electrical Ground | |
| 36 | GND | | | Electrical Ground | |
| 37 | GND | | | Electrical Ground | |
| 38 | RESERVED | | | RESERVED | |
| 39 | RESERVED | | | RESERVED | |
| 40 | GND | | | Electrical Ground | |
| 41 | RX LANE 0+ | | | Module XAUI Output Lane 0+ | |
| 42 | RX LANE 0- | | | Module XAUI Output Lane 0- | |
| 43 | GND | | | Electrical Ground | |
| 44 | RX LANE 1+ | | | Module XAUI Output Lane 1+ | |
| 45 | RX LANE 1- | | | Module XAUI Output Lane 1- | |
| 46 | GND | | | Electrical Ground | |
| 47 | RX LANE 2+ | | | Module XAUI Output Lane 2+ | |
| 48 | RX LANE 2- | | | Module XAUI Output Lane 2- | |
| 49 | GND | | | Electrical Ground | |
| 50 | RX LANE 3+ | | | Module XAUI Output Lane 2+ | |
| 51 | RX LANE 3- | | | Module XAUI Output Lane 2- | |
| 52 | GND | | | Electrical Ground | |
| 53 | GND | | | Electrical Ground | |
| 54 | GND | | | Electrical Ground | |
| 55 | RX LANE 0+ | | | Module XAUI Output Lane 0+ | |
| 56 | RX LANE 0- | | | Module XAUI Output Lane 0- | |
| 57 | GND | | | Electrical Ground | |
| 58 | TX LANE 1+ | | | Module XAUI Output Lane 1+ | |
| 59 | TX LANE 1- | | | Module XAUI Output Lane 1- | |
| 60 | GND | | | Electrical Ground | |
| 61 | TX LANE 2+ | | | Module XAUI Output Lane 2+ | |

| | | | | | |
|----|------------|--|--|----------------------------|--|
| 62 | TX LANE 2- | | | Module XAUI Output Lane 2- | |
| 63 | GND | | | Electrical Ground | |
| 64 | TX LANE 3+ | | | Module XAUI Output Lane 2+ | |
| 65 | TX LANE 3- | | | Module XAUI Output Lane 2- | |
| 66 | GND | | | Electrical Ground | |
| 67 | RESERVED | | | RESERVED | |
| 68 | RESERVED | | | RESERVED | |
| 69 | GND | | | Electrical Ground | |
| 70 | GND | | | Electrical Ground | |

Block Diagram of Adapter Power Supply Circuit

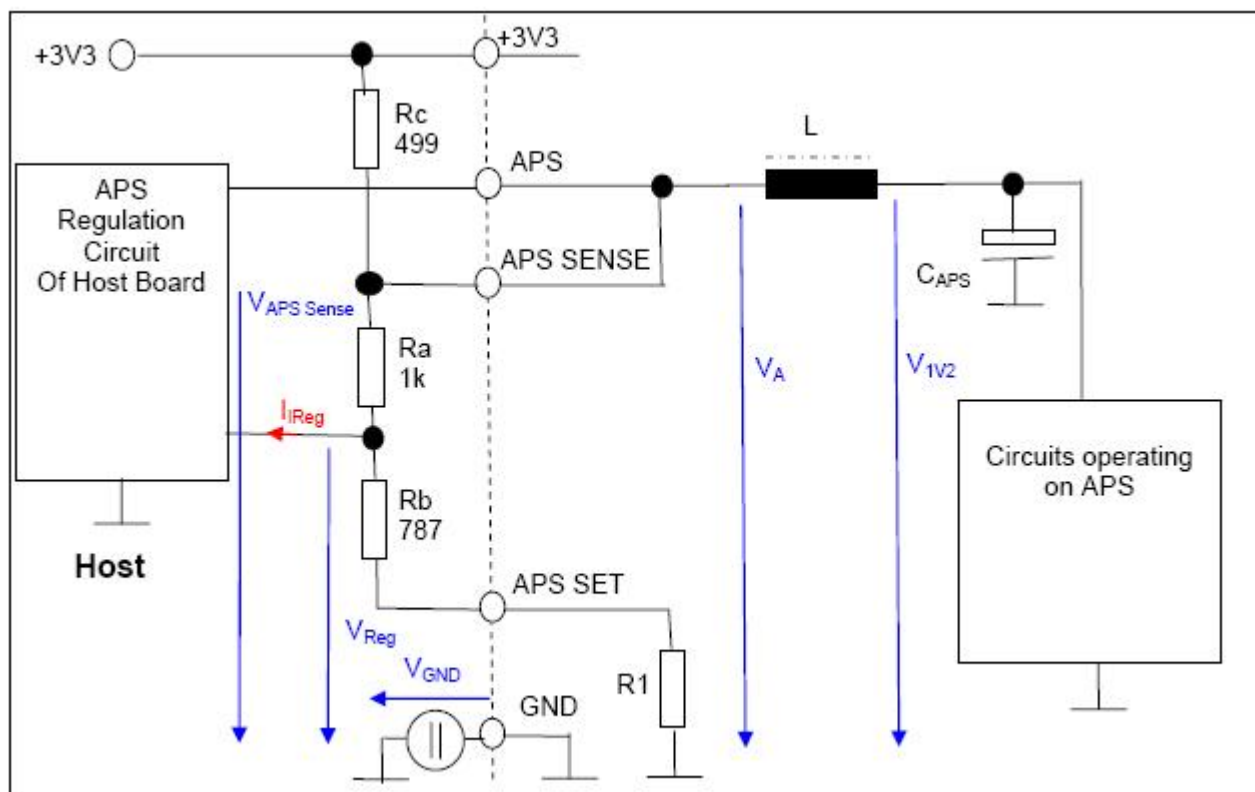

Package Dimensions

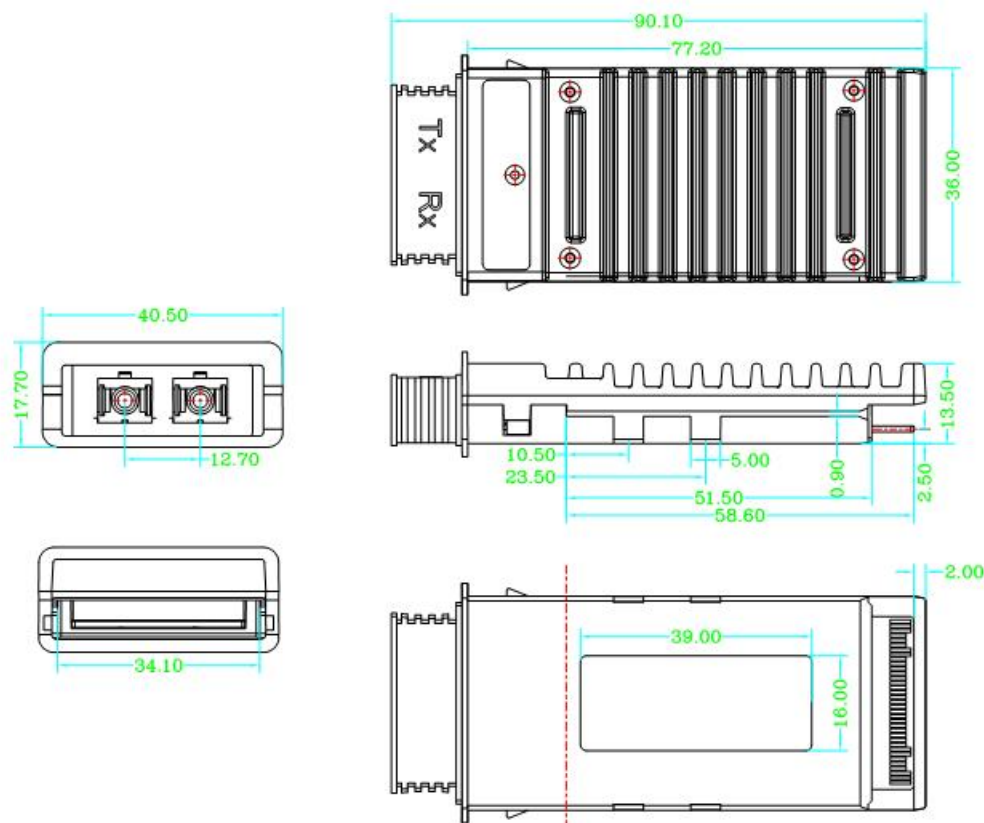

Ordering information

| Part Number | Product Description |
|---------------|--|
| X2-10CW47-80C | X2 1470nm cooled DFB EML, 10Gbps, 80km, -5°C ~ +70°C |
| X2-10CW49-80C | X2 1490nm cooled DFB EML, 10Gbps, 80km, -5°C ~ +70°C |
| X2-10CW51-80C | X2 1510nm cooled DFB EML, 10Gbps, 80km, -5°C ~ +70°C |
| X2-10CW53-80C | X2 1530nm cooled DFB EML, 10Gbps, 80km, -5°C ~ +70°C |
| X2-10CW55-80C | X2 1550nm cooled DFB EML, 10Gbps, 80km, -5°C ~ +70°C |
| X2-10CW57-80C | X2 1570nm cooled DFB EML, 10Gbps, 80km, -5°C ~ +70°C |
| X2-10CW59-80C | X2 1590nm cooled DFB EML, 10Gbps, 80km, -5°C ~ +70°C |
| X2-10CW61-80C | X2 1610nm cooled DFB EML, 10Gbps, 80km, -5°C ~ +70°C |

Ascent Optics reserves the right to make changes to the product(s) or information contained herein without notice. No liability is assumed as a result of their use or application. No rights under any patent accompany the sale of any such product(s) or information. Edition: Apr. 2019 Published by Ascent Optics Co., Ltd. Copyright © Ascent Optics All Rights Reserved.